

Description

Illustration

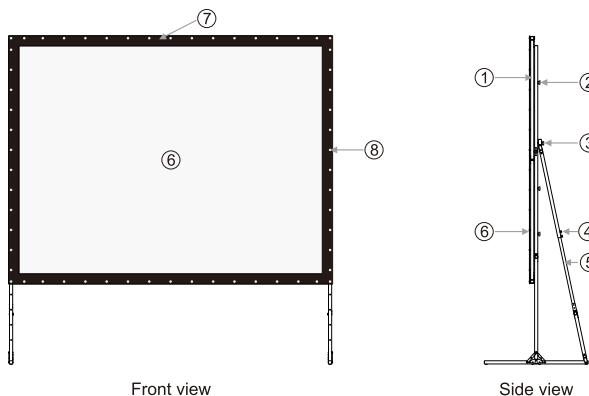

Front view

Side view

Screen parts

①	Main frame	⑤	Leg tube
②	M8 x 53 mm screw	⑥	Fabric
③	M8 x 90 mm locknut	⑦	Fabric black border
④	Leg screw	⑧	Fabric button

Accessories

■ Main frame (1pc)

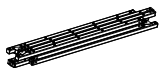

■ Left side leg (1pc)



■ Right side leg (1pc)



■ Fabric package bag (1pc)



■ White screen(1pc)



■ Gray screen (Optional)



■ M8x53 mm screw (4 pcs for 100" ; 6 pcs for 120" and 150")



■ M8x90 mm locknut (2pcs)



■ Accessory bag (1pc)



■ Manual instruction (1pc)

Warning

- Please read the following as any damage to the screen surface will affect the quality of the picture:
 - Don't touch the screen surface with hands.
 - Don't write or draw on the screen surface.
 - Don't poke screen fabric with finger or edge tools.
 - Clean the fabric with soft cloth and lukewarm water. Don't use any detergent or any diluent cleanser.
- To avoid injury, two people are necessary for both assembly and storage.
- Please use in a location shielded from the elements, especially wind. A strong wind may cause the screen to fall. All pieces of the frame and stand must be used together. The screen can be used separately.
- To prevent unnecessary damage, the operating and maintenance of the screen should be done by adults.
- Please fold up screen and return all parts into the case after every use.



Ignoring the safety warnings may lead to injuries and/or damaging the product.



Store back into transporting case after use.



Avoid conditions such as wind and rain when used outside.

Do not take apart and replace with unknown parts. If there are any problems, please contact your local dealer. product specifications are subject to change.

Specifications

Format	Model	Specification (In)	Viewing area		Screen dimension		B1 (mm)	C1 (mm)	Net weight (kg)
			W (mm)	H (mm)	L (mm)	A (mm)			
4:3	LS-Z100	100"	2032	1524	2202	2629	85	85	16.1
	LS-Z120	120"	2438	1828	2618	2958	90	90	18.9
	LS-Z150	150"	3048	2286	3256	3634	104	104	22.7

Note: The data is subjective to change with informing. Refer to real product for accuracy.
(L length has tolerance of $\pm 5\text{mm}$)

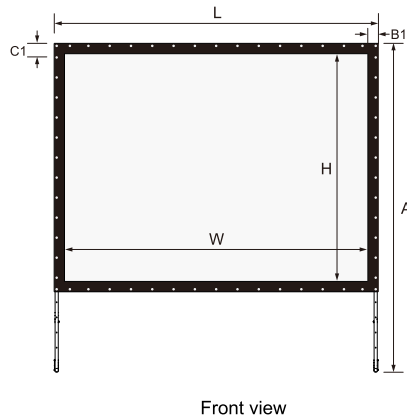

Tube Section Dimension

Name	Size	Application
Fastfold screen stand	32mmx32mm	For all fastfold no larger than 150"

Note: The data is subject to change without informing. Refer to real product for accuracy.

Installation

Main Frame Installation

1. Open the flight case, press down the corner link rod as the arrow sign indicates till the rod fully outspreads, then take out the parts and lay it on a smooth location (Figure 1 - 2).

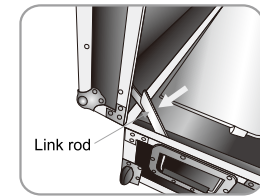

Figure 1

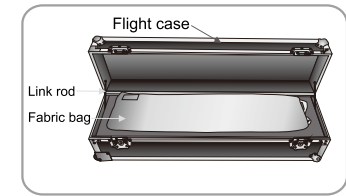

Figure 2

2. Lay the main frame on the floor with the fabric rivet facing up. Stretch the tuning joints as the arrow indicates (Figure 3 - 4).

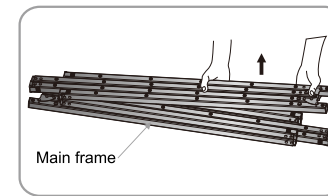

Figure 3

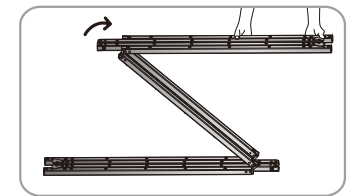

Figure 4

3. To secure frame, "click" hinges into place. Extend horizontal side of main frame (Figure 5 - 6).

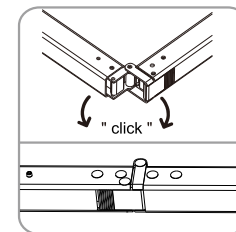

Figure 5

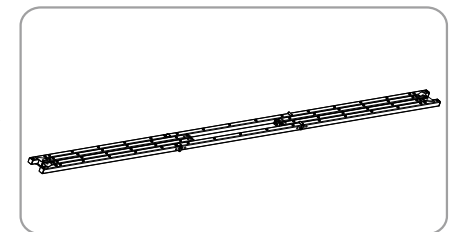

Figure 6

Installation

4. Extend vertical sides of the frame and "click" hingers into place (Figure 7).

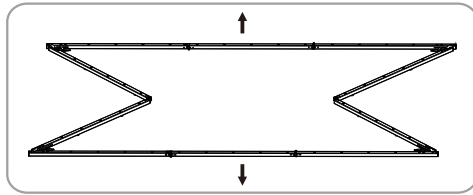

Figure 7

5. Make sure four corners are 90 degree then sure with link rod (Figure 8).

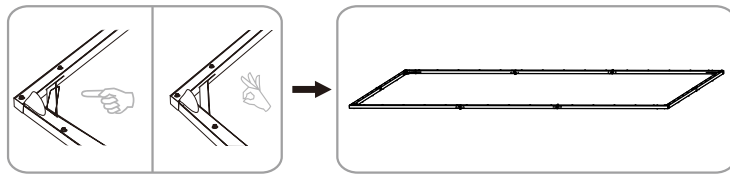

Figure 8

Figure 9

Fabric Installiton:

1. Unfold screen fabric and lay over frame (Figure 10 - 11).

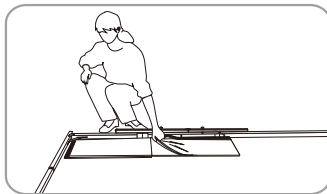

Figure 10

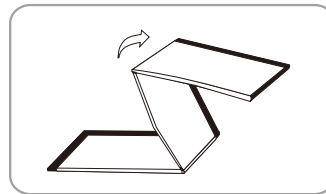

Figure 11

Disassembly

7. Unfasten the horizontal sides of main frame so that the main frame is fully folded (Figure 37 - 38).

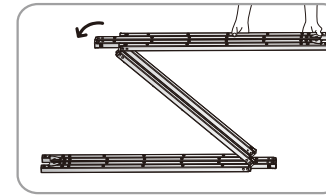

Figure 37

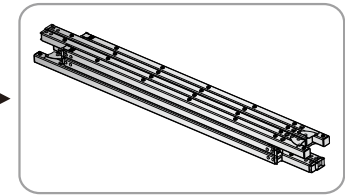

Figure 38

8. Put legs and main frame in the case and fasten them as Figure 39 . Put the accessory bag inside. Place the clapboard in place and put the fabric bag on it (Figure 40).

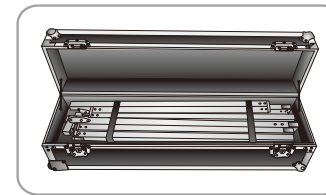

Figure 39

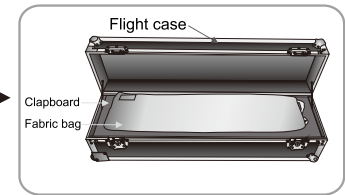

Figure 40

9. Pull up the flight case corner link rod, close the flight case and fasten it (Figure 41 - 42).

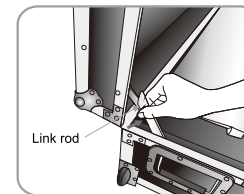

Figure 41

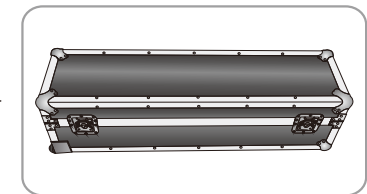

Figure 42

Disassembly

4. Screw off the locknuts on both legs and as Figure 29, and take off the legs. Pull up the legs' corner link rod and screw off the screws, retract the leg tubes and fasten the screws again. Unfasten the turning joint locks and fold the frame and legs (Figure 30 - 32).

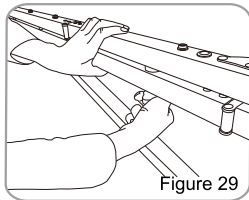

Figure 29

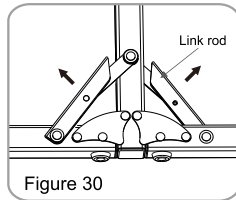

Figure 30

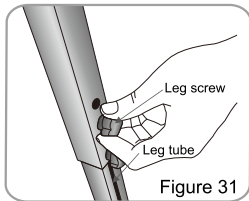

Figure 31

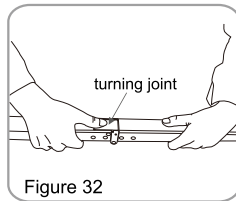

Figure 32

5. Pull up the corner link rods on the main frame and unfasten the turning joints on the vertical side of main frame (Figure 33 - 34).

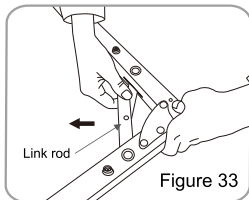

Figure 33

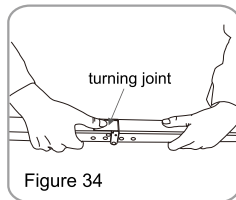

Figure 34

6. Fold the main frame as arrows indicate (Figure 35 - 36).

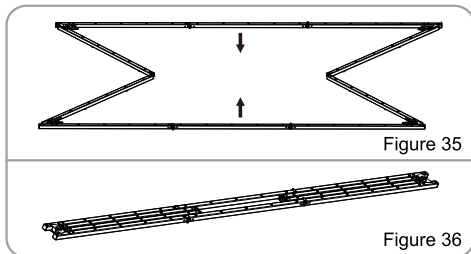

Figure 35

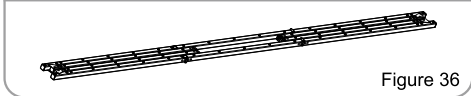

Figure 36

Installation

2. Snap screen buttons to frame. Start at frame corners and finish at frame sides (Figure 12 - 14).

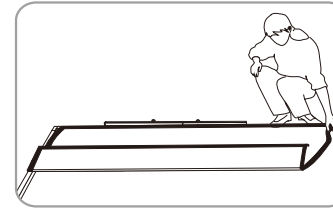

Figure 12

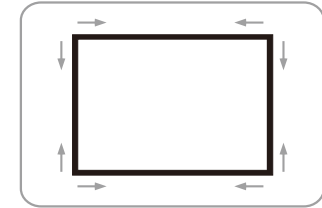

Figure 13

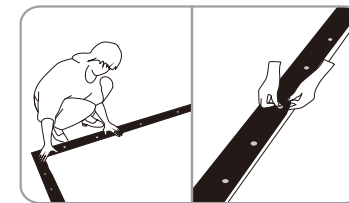

Figure 14

Legs Installation

1. Unpack left and right frame legs and extend. Put all joints in place and fully outspread the corner link rod (Figure 15).

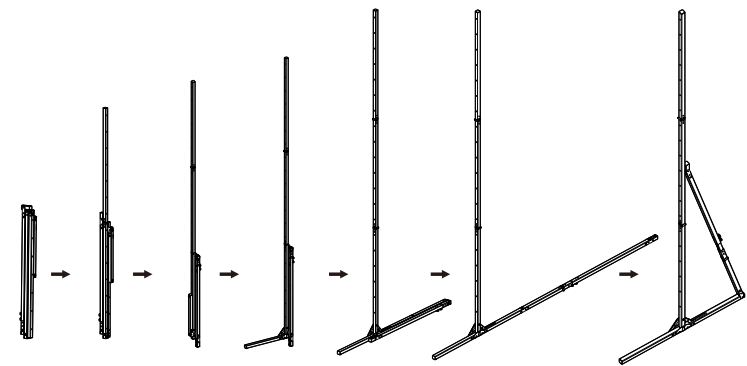

Figure 15

Installation

- It is suggested to install the main frame on a flat ground. Put the completed legs besides the main frame short side and fix it to the main frame according to required screen height by means of M8 x 53 mm screw (Figure 16 - 17). (Note: Leave one hole on the main frame for the fastening of the M8 x 60 mm screw.)

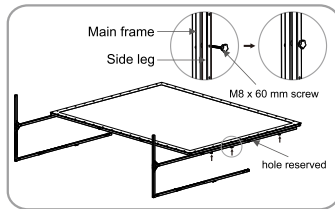

Figure 16

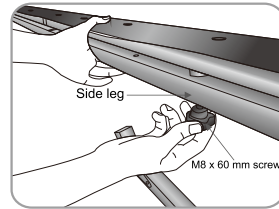

Figure 17

- Unfasten the locknut on legs and pull out the tubes and leave some hole for M8 x 90 mm locknut and fasten it (Figure 18 - 20).

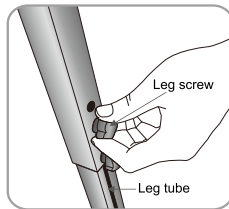

Figure 18

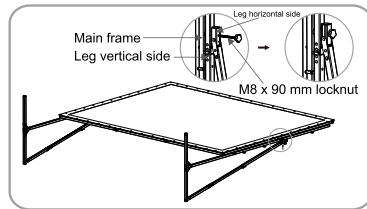

Figure 19

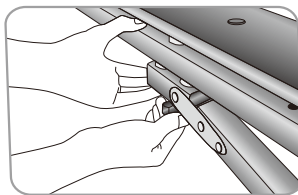

Figure 20

- Lift up the screen and installation is completed (Figure 21).

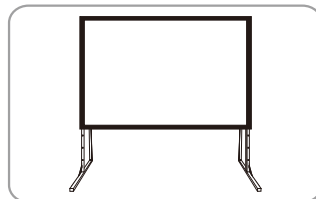

Figure 21

Disassembly

- Lay down the screen on flat floor with screen fabric facing up (Figure 22).

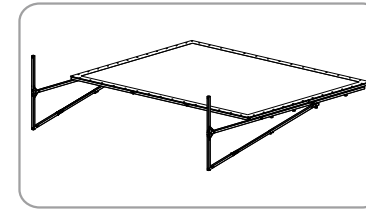

Figure 22

- Take off the fabric from the frame by releasing the buttons (Figure 24). Clean the fabric if necessary. Double up the fabric along the short sides as Figure 24, then double up again as Figure 25. (100" fabric double up thrice, 120" and 150" fabrics double up quartic.) Then double up again as Figure 26 indicates. Leave the black border alone in case of scratch. (two operators are required.)

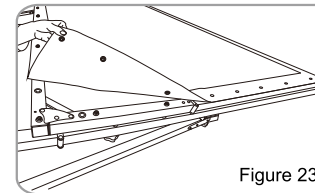

Figure 23

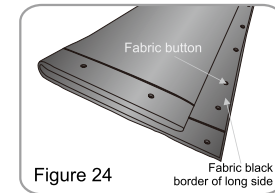

Figure 24

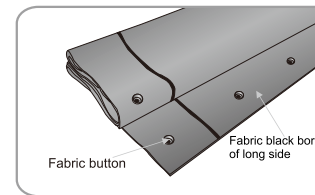
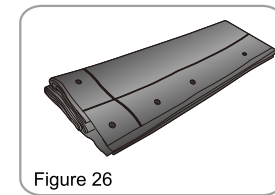

Figure 26



- Put the folded fabric into the fabric bag and fasten the slide (Figure 27 - 28).

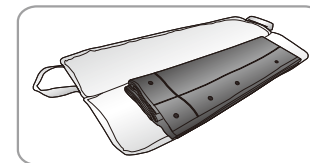

Figure 27

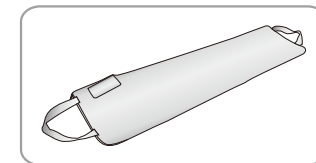

Figure 28